



DIAMOND DRESSER



What is a Diamond Dresser?

A diamond dresser has single or multiple diamonds mounted on a tip or shank by a sintering process. Diamond dressers are widely used for truing and dressing of abrasive grinding wheels.

The method of truing and dressing of the grinding wheel has a large impact on the grinding performance of the grinding wheel, work-finish and size.

With Asahi Diamond's range of dressers, we can meet all your needs for grinding wheel forming.

Note, that products marked with a * in the catalog are products that meet the IDAS specifications established by the Industrial Diamond Association of Japan, so please also make use of these products.

SHAPES AND DIMENSIONS OF DIAMOND DRESSERS IN THE IDAS*

(* Industrial Diamond Association Standards)

Scope

This standard describes the shapes and dimensions of diamond dressers used for dressing, truing and forming, with the exclusion of roller dressers and forming block dressers.

Terminology

The terms used in the Standard Definitions are as follows:

Dressing

The process of exposing new abrasive grain and new sharp cutting edges.

Truing

The process of forming the working face of the grinding wheel so that it is concentric to the axis of the grinding wheel.

Forming

The process of shaping the precise form to the grinding wheel, screw grind wheels and geared grind wheels into the required shape.

Types

The types of dressers can be catalogued based on the diamonds used into the following categories.

Singlepoint Dressers

Dressers with one diamond mounted in one shank.

Forming Dressers

Dressers with a single diamond that has been polished to the required shape and dimensions mounted in one shank.

Multipoint Dressers

Dressers with multiple diamonds mounted in one shank.

Impregnated Dressers

Dressers with diamond abrasive grain that has been fixed into the required shape and dimensions using a metallic bonding material, and attached to a shank.

Standard shapes and dimensions

Standard diamond shapes

Standard diamond shapes and their referring symbols are as follows.

Standard dresser shank tips

Standard dresser shank tips and their referring symbols are as follows.

Standard diamond shapes and their referring symbols

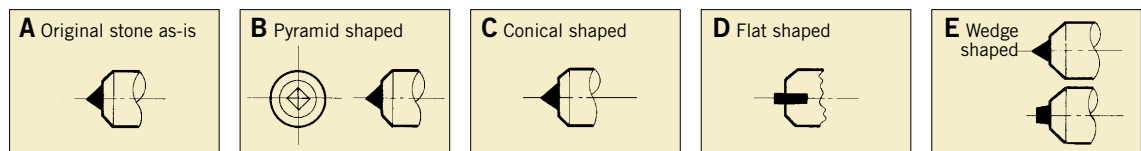

Note: A is not polished, B, C, D, E are polished.



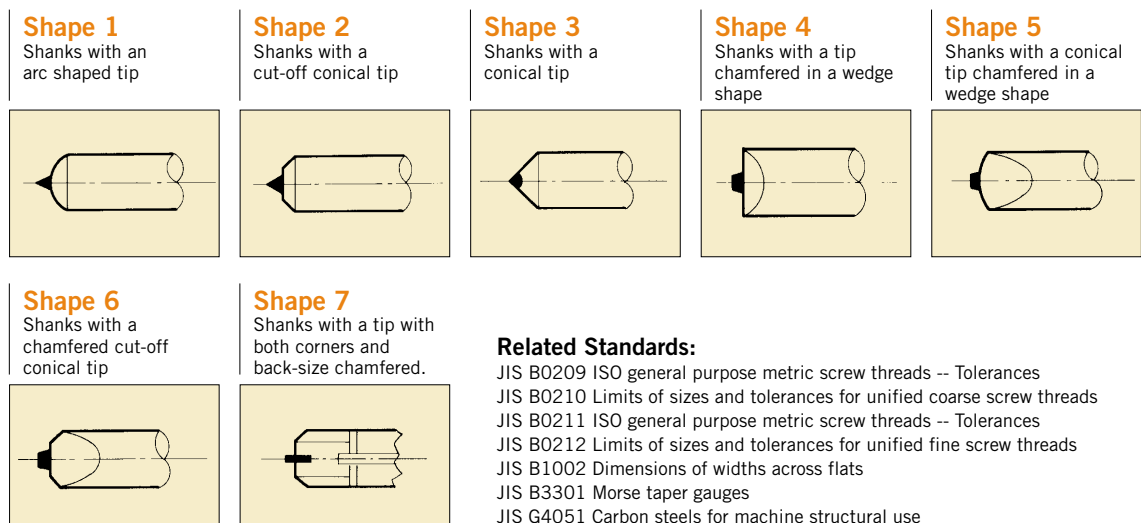





Standard dresser shank tips and their referring symbols

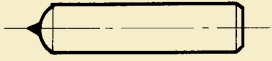
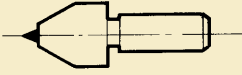

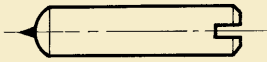
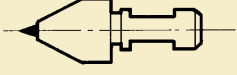
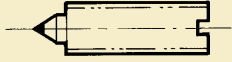
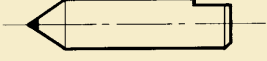
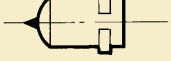
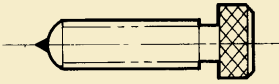
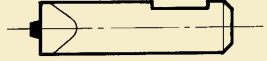
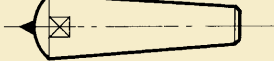
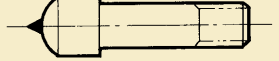
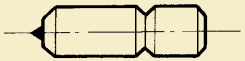
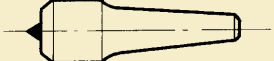
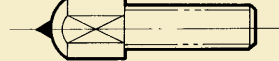
Related Standards:

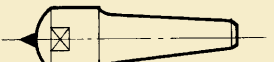
- JIS B0209 ISO general purpose metric screw threads -- Tolerances
- JIS B0210 Limits of sizes and tolerances for unified coarse screw threads
- JIS B0211 ISO general purpose metric screw threads -- Tolerances
- JIS B0212 Limits of sizes and tolerances for unified fine screw threads
- JIS B1002 Dimensions of widths across flats
- JIS B3301 Morse taper gauges
- JIS G4051 Carbon steels for machine structural use

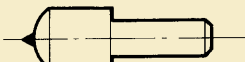
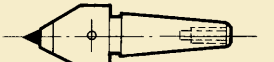
STANDARD DRESSER SHANK SHAPES AND THEIR REFERRING TOOLS

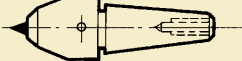
<p>A</p> 	<p>J</p> 	<p>S</p> 
<p>B</p> 	<p>K</p> 	<p>T</p> 
<p>C</p> 	<p>L</p> 	<p>U</p> 
<p>D</p> 	<p>M</p> 	<p>V</p> 
<p>E</p> 	<p>N</p> 	<p>W</p> 
<p>F</p> 	<p>P</p> 	<p>X</p> 
<p>G</p> 	<p>Q</p> 	
<p>H</p> 	<p>R</p> 	

SINGLEPOINT DRESSERS

Choosing a diamond

Asahi Diamond always has a vast stock of raw diamonds, ready to meet our customer's needs immediately. When obtaining raw stones, we make sure that the stones have several sharp edges, have no cracks, contain no carbon, etc.,. Also, for those customers that would like to choose their own raw stone, we also have diamonds that have not yet been set.



Elements that decide the diamond ct

When ordering a singlepoint diamond dresser, please provide the following information.

Type of abrasive grinding wheel:

- (a) Abrasive
- (b) Grit size
- (c) Hardness
- (d) Bonding material
- (e) Abrasive grinding wheel diameter and width

Usage conditions:

- (a) Angle of attachment
- (b) Wet or dry
- (c) Depth of cut
- (d) Peripheral speed
- (e) Material to be worked and required face finish
- (f) Plane grinding or forming grinding
- (g) Machine and precision

For vitrified or resin-bonded wheels with a 25mm width, a hardness of H ~ M, and a grit mesh size of #40 ~ #80, a diamond of a weight specified in table below is used, and for wheels with larger diameters or widths, please calculate using the following equations as a guide.

Grinding wheel diameter (mm)	75	150	225	375
ct	0.30	0.50	0.75	1.0

$$\frac{\text{Diameter (inches)} + 2 \times \text{Width (inches)}}{10} \text{ or } \frac{\text{Diameter (mm)} + 2 \times \text{Width (mm)}}{250} = \text{ct}$$

Diamond Mount

Except when given special instructions, almost all Asahi Diamond's dressers are sinter mounted, eliminating the chance that the raw stone will move or fall out in use.

We would like you to be careful when changing the axis of a dresser, as if you accidentally grind down the sinter mount of the diamond, the entire mount may fall out.

So, when changing the axis, please contact us as soon as possible.

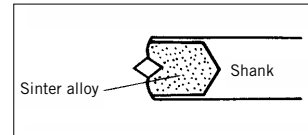

Dressing Procedure

The roughness of the grinding edge depends on the peripheral speed and depth of cut, and the total depth of cut of the final dressing must not exceed 0.02mm.

When performing a rough dressing, you can increase this number a little, but you can also increase the life of a diamond by performing a number of light dressing passes rather than one heavy dressing pass. The wheel speed impacts directly on the roughness of the finished face, so please take care to select the right speed.

Angle of attachment

The diamond dresser should be attached at an angle of 10 ~ 15 degrees from the horizontal axis of the grinding wheel, and at an angle of 10 degrees to the circumference of the wheel. If you rotate the dresser frequently, you can maintain a sharp point and perform ideal dressings.

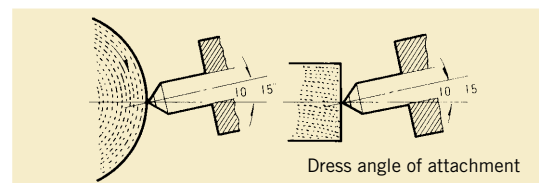

Repairs

Please make any repairs to the diamond dresser as soon as possible. If you continue to use the dresser in a less than optimal condition, it may become irreparable, and cost you more than necessary.

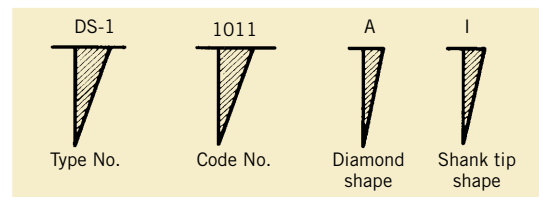

Order Types

When ordering diamond tools, please give the shape type, standard dimension code no and diamond shape as follows.

DS-1 **A1A-C2A** IDAS

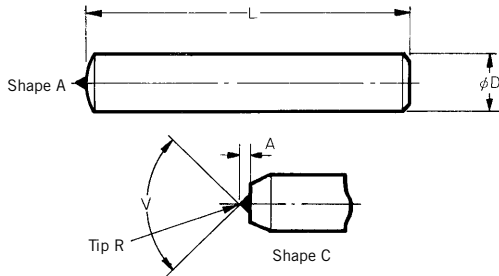

Code No.	D	L	Code No.	D	L
1101	6	25	1112	11	35
1102*	6	30	1113	11	40
1103	8	25	1114*	11	50
1104*	8	30	1115	11	60
1105	8	40	1116*◆	11	100
1106*	8	50	1117	12	40
1107*	8	100	1118*	12	50
1108	10	35	1119*◆	12	100
1109	10	40			
1110*	10	50			
1111*◆	10	100			

Code No.	D	L	V	R	A
1120	6.3	25.4	80°	0.1	1.5
1121	9.5	35.0	60°	0.1	1.5
1122	11.0	40.0	80°	0.1	1.5

* Items meeting IDAS specifications Unit: mm
 ◆ Standard stock items



DS-2 **A1G-C3G** IDAS

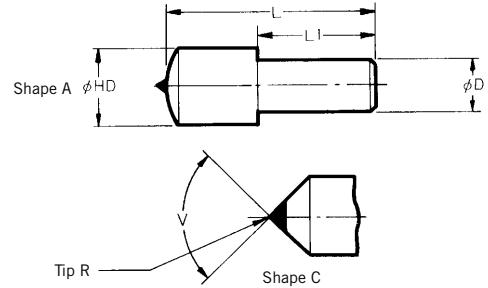

Code No.	D	HD	L	L1
1201*	6	12	27	12
1202*	6	12	35	20
1203	6.35	9.5	25	11
1204	6.35	9.5	28.5	12.7
1205	6.35	12.7	32	12.7
1206	7.95	11	28.5	12.7
1207*	8	12	26	16
1208	8	12	35	20
1209	9.5	11	25	16
1210*	11	16	35	20
1211*	11	16	40	25
1212	11	16	22	12.7

Code No.	D	HD	L	L1	V	R
1213*	4.7	8	16	8	90°	0.2

* Items meeting IDAS specifications Unit: mm



DS-3 **A2H-CH3** IDAS

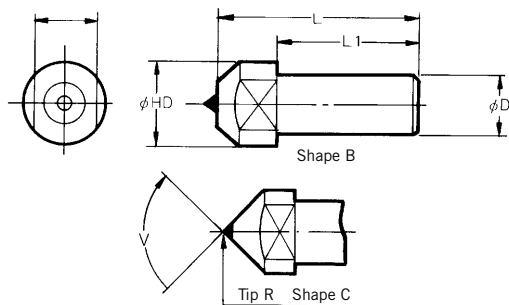

Code No.	D	HD	L	L1	H
1301*	6	12	27	12	8
1302*	6	12	35	20	8
1303	6.35	9.5	25	17	6.5
1304	11	16	37	18	13
1305	11	16	28	20	13
1306*	11	16	35	20	13

* Items meeting IDAS specifications Unit: mm

DS-4 **A1M** IDAS

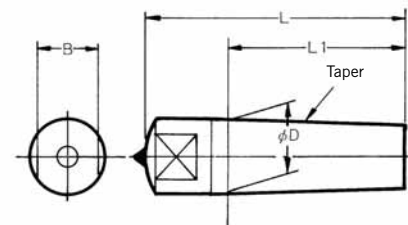

Code No.	D	L	B	L1	L2	Taper
1401*	6.3	26	5	22.0	4	1/50
1402*	8.7	33	7	24.0	6	1/50
1403-1*	9.0	27	7	21.0	5	MT#0
1403-2*	9.0	31.5	7	25.5	5	MT#0
1404-1*	12.0	36	10	27.0	6	MT#1
1404-2*	12.0	49.0	10	40.0	8	MT#1

* Items meeting IDAS specifications Unit: mm

DS-5 **A3C** IDAS

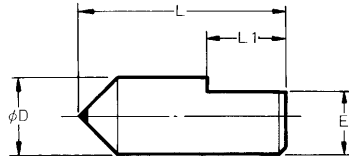

Code No.	D	E	L	L1
1501*	11	9.5	40	3
1502	11.1	11	38	3

* Items meeting IDAS specifications Unit: mm

DS-6 **A1U-C2U** IDAS

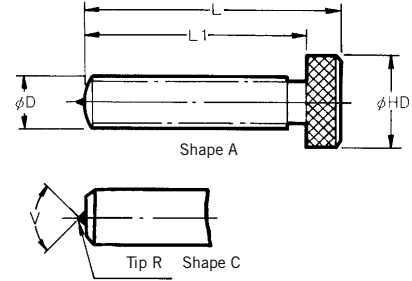

Code No.	D- (Thread)	HD	L	L1
1601*	7.93-(24)	13	51	43
1602*	9.52-(24)	15	57	49
1603*	9.52-(24)	16	65	57
1604*	9.52-(24)	19	44.5	32

* Items meeting IDAS specifications Unit: mm

DS-7 **A1P** IDAS

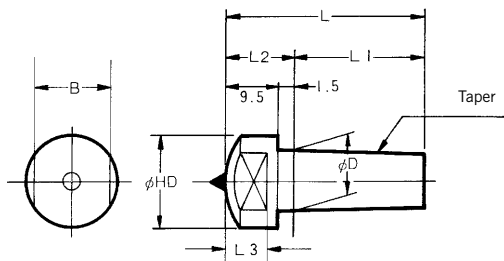

Code No.	D	HD	L	L1	L2	L3	Taper	B
1701*	5.8	9	31	21.0	9.5	7	1/40	8
1702*	7.1	10	31	21.0	9.5	7	1/40	8
1703*	9.0	12	31	21.5	9.5	7	MT#0	10
1704*	9.0	16	42	25.5	14.0	9	MT#0	13
1705*	12.0	18	57	40.0	14.0	9	MT#1	14

* Items meeting IDAS specifications Unit: mm



DS-8 **A2E** IDAS

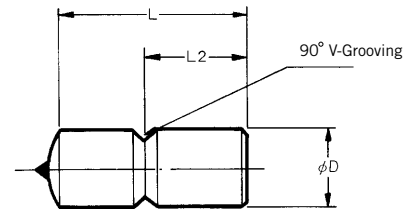

Code No.	D	L	L2
1801*	6	8	4
1802*	10	16	7
1803*	10	20	9
1804*	11	35	16
1805*	11	40	20

* Items meeting IDAS specifications Unit: mm



DS-9 A1S IDAS

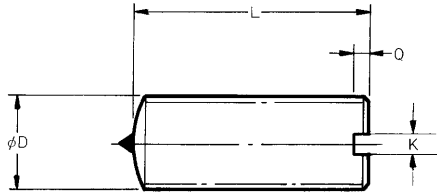

Code No.	DxPitch	L	K	Q
1901*	M8x1.0	16	1.0	2
1902*	M8x1.25	40	1.5	2
1903*	M12x1.50	40	1.5	2

* Items meeting IDAS specifications Unit: mm

DS-10 IDAS

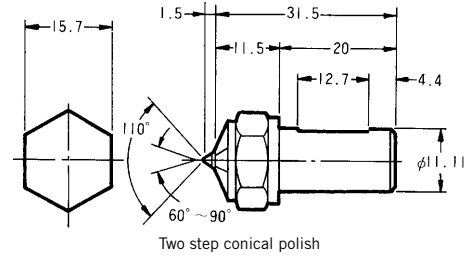

DS-13 A1V IDAS

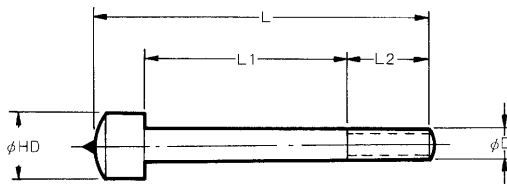

Code No.	DxPitch	HD	L	L1	L2
1321*	M4x0.7	11	45	23	15
1322*	M5x0.8	11	60	35	15

* Items meeting IDAS specifications Unit: mm



DS-14 A1W IDAS

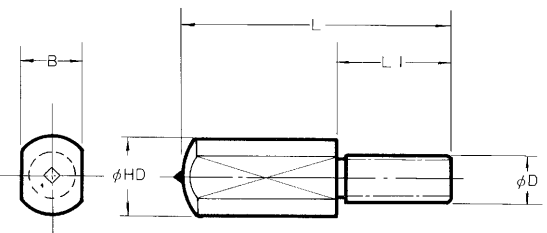

Code No.	DxPitch	HD	B	L	L1
1421*	M6x1	10	8	35	15
1422*	M12x1.5	16	13	35	15

* Items meeting IDAS specifications Unit: mm

DS-15

Wooden handle
12Dx150ℓx280ℓ

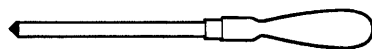

DS-16

Knurled handle
12Dx200ℓ

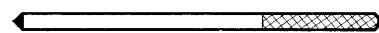

DS-17 C2B IDAS

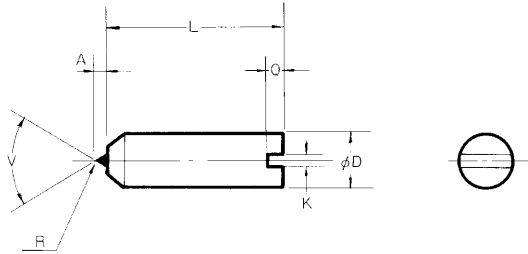

Code No.	D	L	V	R	K	Q	A
1701*	6	19.5	90°	0.2	1.0	1.5	1.5
1702*	7	11.5	90°	0.2	1.0	1.5	1.5
1703*	7	19.5	90°	0.2	1.0	1.5	1.5
1704*	8	30.0	60°	0.1	1.2	2.5	1.5

* Items meeting IDAS specifications Unit: mm

DS-18 A2N IDAS

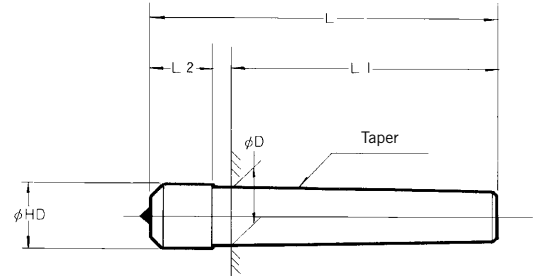

Code No.	D	HD	L	L1	L2	Taper
1801*	12.7	70	55	13	MT#1	

* Items meeting IDAS specifications Unit: mm

DS-19 A1N IDAS

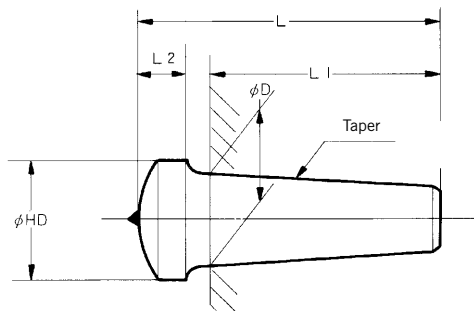

Code No.	D	HD	L	L1	L2	Taper
1901*	7	9	23	18	3.5	**1/20

* Items meeting IDAS specifications Unit: mm
 ** Metric Taper



FORMING DRESSERS

The shape of a forming diamond dresser changes depending on the machine and application. Also, please note that the shape of the diamond is different to a singlepoint diamond dresser. The major differences between a forming diamond dresser and a singlepoint diamond dresser are as follows.

Wedge shape

Forming diamond dressers have a wedge shape with an angle of between 55° and 70° so that the corner of the diamond does not touch the grind wheel. The roof has a width of 1.5 ~ 3.0 mm, and this dimension makes the blade stronger and allows both sides to be used.



The blade has a radial point

It is usually said that the sharper point diamonds provide better forming and usually have a radius of 0.2 mm.

Has a negative angle

The blade has a negative angle to increase its strength

The protruding length of the blade is limited

*When ordering

There are many different types of forming diamond dressers available, so when ordering, please either give the type number from the catalogue, or for items varying from the catalogue or not in the catalogue, please give the necessary information including type of spindle, tip radius, tip angle, etc.

DF-1 E6K Toyota Gendron Type IDAS

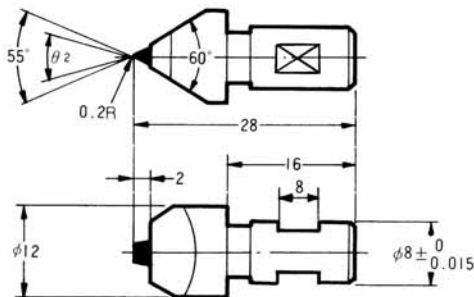

DF-2 E6R Ohkuma Fortuna Type IDAS

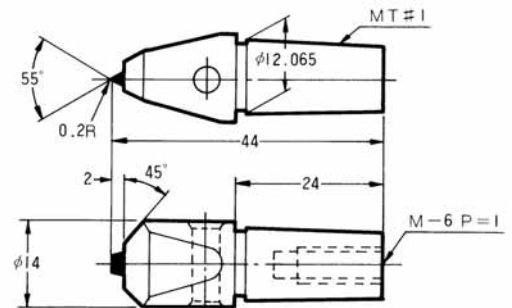

DF-3 E6Q Shout Type IDAS

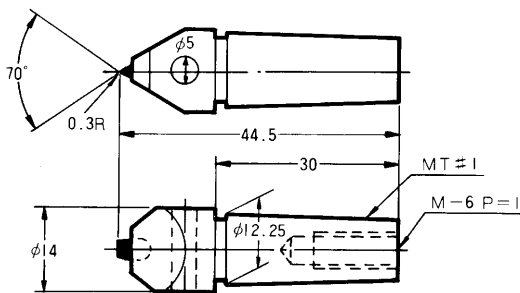

DF-35 E6K Ohkuma Type

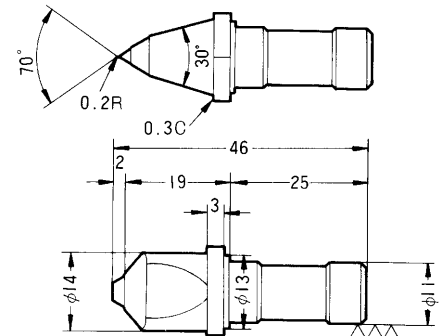

DF-4 E4K Mitsui Seiki Type IDAS

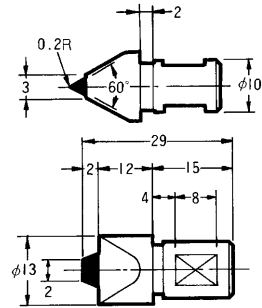

DF-5 E6F Diamond Form Type IDAS

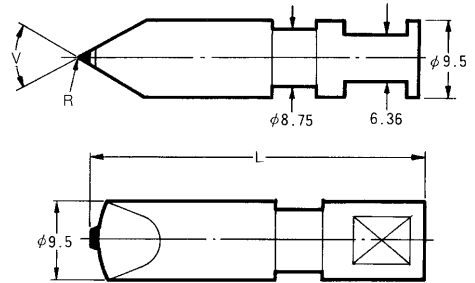

Code No.	V	R	L
2501*	40°	0.05	35
2502*	40°	0.125	35
2503*	40°	0.125	44.5
2504*	40°	0.25	44.5
2505*	60°	0.125	35
2506*	60°	0.25	35
2507*	60°	0.25	44.5
2508*	60°	0.5	35
2509*	60°	0.5	44.5
2510*	90°	0.75	44.5

* Items meeting IDAS specifications

Unit: mm

DF-6 E4D Nippei Type IDAS

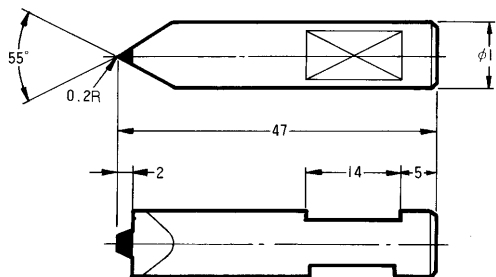

DF-7 Nippei Type

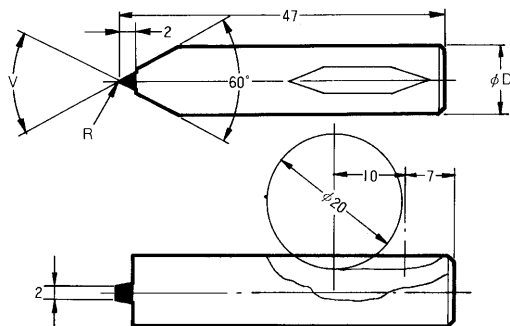

DF-8 Nippei Type

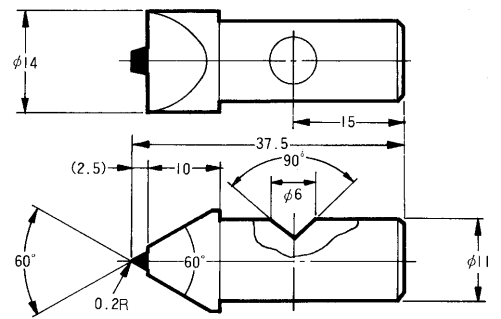

DF-9 Toyota Type

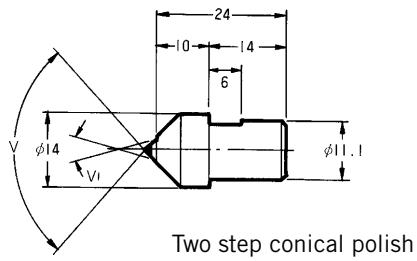

DF-10 Naxus Union Type

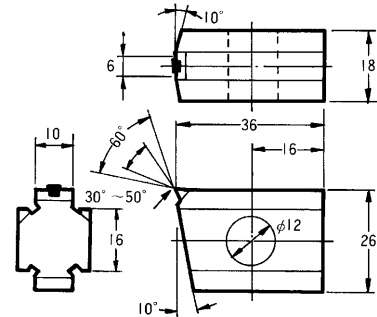

DF-11 Hoglund Type

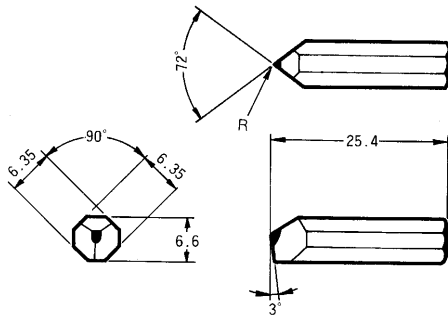

DF-12 E2L IDAS

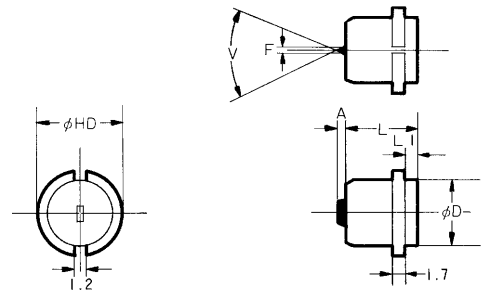

Code No.	D	HD	L	L1	V	F	A
3201*	7.9	11.0	10	1.3	46°	0.038	2
3202*	7.9	11.0	10	1.3	46°	0.050	2
3203*	7.9	11.0	10	1.3	46°	0.075	2~2.5
3204*	7.9	11.0	10	1.3	46°	0.130	2.5~3
3205*	7.9	11.0	10	1.3	46°	0.180	3~3.5
3206*	7.8	10.5	9	1.0	43°	0.180	2
3207*	7.8	10.5	9	1.0	25°	0.100	2

* Items meeting IDAS specifications

Unit: mm

DF-13 C3C IDAS

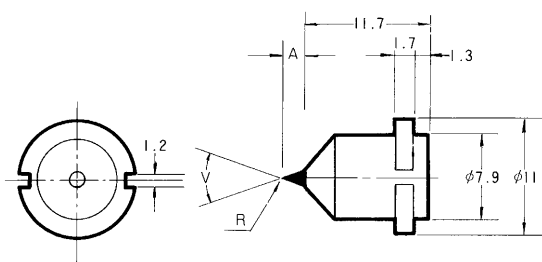

Code No.	V	R	A
3301*	35°	0.045	2.0
3302	35°	0.050	2.0
3303*	35°	0.065	2.0
3304*	35°	0.090	2.5~3.0
3305*	35°	0.125	2.5~3.0
3306*	35°	0.130	2.5~3.0
3307*	46°	0.050	2.0
3308*	46°	0.125	2.5~3.0

* Items meeting IDAS specifications

Unit: mm

Close up of the D-section (4/1)

Unit: mm

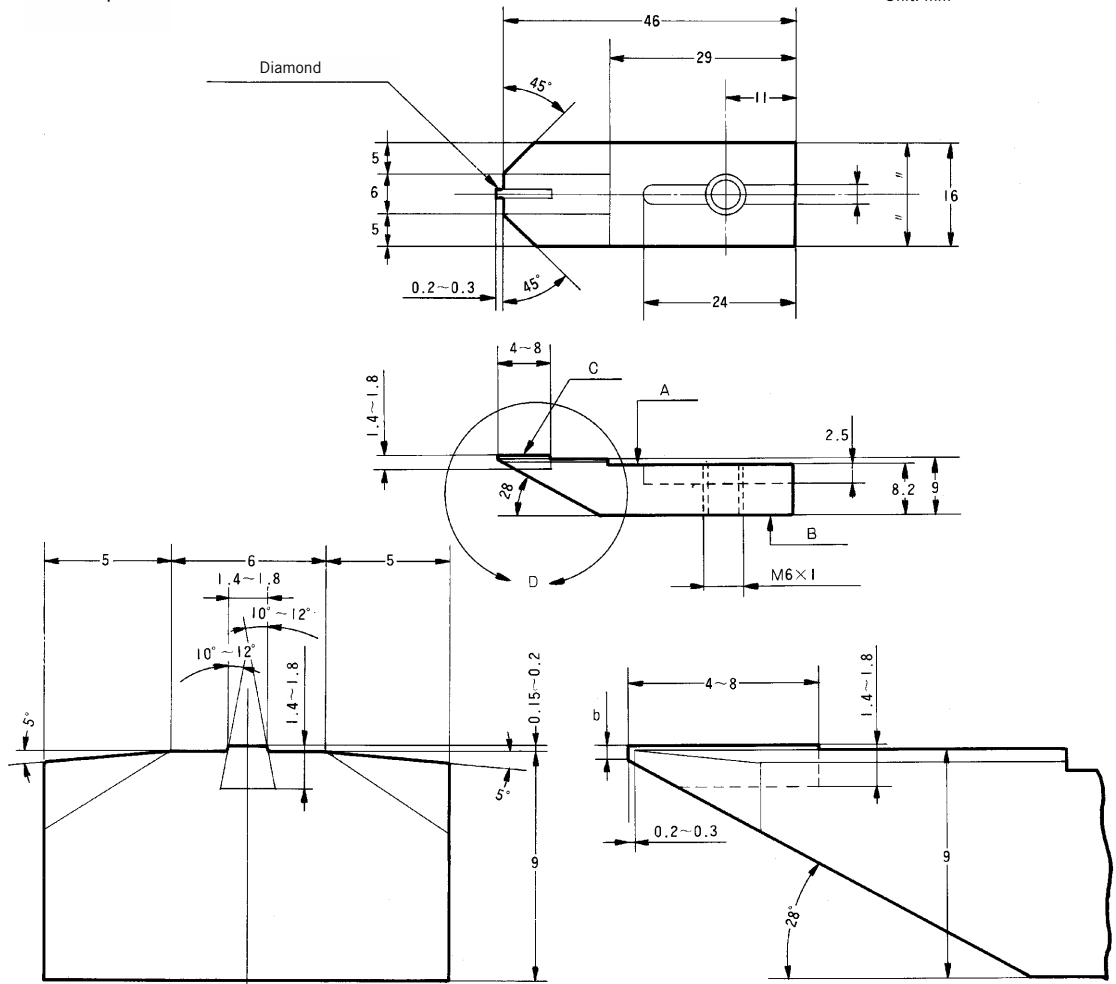

Note:

Face A and Face B } Are exactly parallel
 Face B and Face C }

Code No.	Module	b Dimensions
3401*	0.5~0.9	0.2
3401*	1~5	0.5

* Items meeting IDAS specifications

Unit: mm



MULTIPOINT DRESSERS

Multipoint diamond dressers have several comparatively small and uniform diamonds from 1/20 to 1/2 ct size mounted securely along the length of the axis.

The diamond layout depends on the diameter and width of the grinding stone, but because three or five diamonds are embedded in two or three rows, and multipoint diamond dressers can be used for even dressing continuously until the embedded diamonds have been completely used up. Repairs during the life of the product are not necessary, saving money and time.

Further, the size of the diamond used in the dresser depends on the diameter, width, etc. of the grinding wheel, and so large grinding wheels require large diamonds. Dressers with large diamonds are expensive, but in the case of multipoint diamond dressers, several stones hit the grinding wheel at the same time, meaning that smaller stones can do the job, and prices can be kept down.

For the metal holding the diamonds for multipoint diamond dressers, we have taken into account the coefficient of heat expansion and mechanical strength of diamond while using a hard metal. This will ensure that the diamond will not loosen or fall out from the heat and pressure of use.

Multipoint diamond dressers can be used for truing and dressing, but they are particularly suited to use in rough finishes such as conical grinding, inner-surface grinding, center-less grinding, etc.; finishing; and dressing of convex surfaces and the side of grinding wheels. When placing an order, please specify the number of diamonds on the face and the number of rows, such as five diamonds for five rows or three diamonds for three rows.

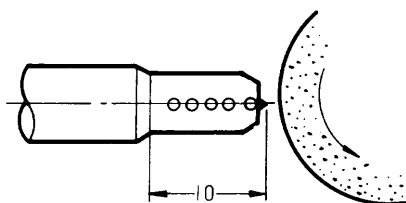

This tool is a singlepoint diamond dresser, but it can be used with out making repairs, and is a very economical product.

DM-1 1 diamond, 3 rows

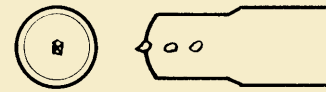

DM-2 1 diamond, 5 rows

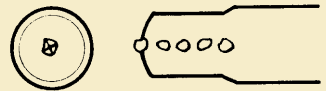

DM-3 3 diamonds, 3 rows



DM-4 5 diamonds, 3 rows



This type is generally used in place of a singlepoint diamond dresser.

It can be very useful where a singlepoint dresser is soon worn out.

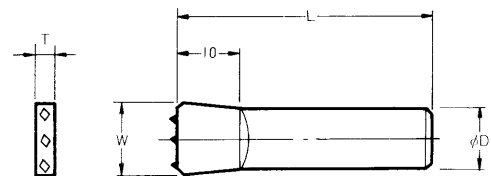

Code No.	Diamond Layout	T	W	D	L
5101	3x1	3.2	12	11	50
5102	3x3	3.2	12	11	50
5103	4x1	3.2	12	11	50
5104	5x1	3.2	12	11	50
5105	8x1	4	12.7	11	50

Unit: mm



Code No.	D	L	Code No.	D	L
6101	11	30	6104	11	60
6102*	11	50	6105	11	65
6103♦	12	50			

* Items meeting IDAS specifications
♦ Standard stock items 3 diamonds, 3 rows and 5 diamonds, 3 rows

Unit: mm

BLADE TYPE MULTI POINT DRESSERS

Blade type multipoint diamond dressers are used differently from the conventional method of dressing, which has at least two diamonds in contact with the grinding wheel at the correct angle.

Blade type multipoint diamond dressers are designed for use in line, step, radius and profile adjustment, and they have been created to tackle problems that couldn't be corrected with standard singlepoint diamond dressers. Diamonds and bonding material used are the same as for multipoint diamond dressers, and the shape of the dresser is determined by the shape, dimensions and grit-size of the grinding wheel being used. Blade type multipoint diamond dressers can be used till the end of their life without any repairs, making them very economical.

The advantage of using multi point diamond construction blades is that because they use small diamonds mounted in a narrow width, which provides for better forming capabilities, the number of rows can be changed.

When using the blade type multipoint diamond dresser, ensure that at least two diamonds are in contact with the grinding wheel and that sufficient coolant is provided to avoid overheating.

When ordering, please specify the number of rows to be mounted on the face, and the axis dimensions and angle.

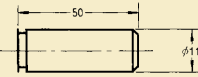
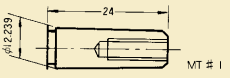
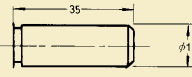
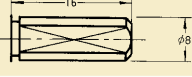
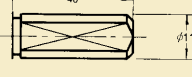
Code No.	Angle	Axis Dimensions
7100	0	
7110	-10°	
7200	0	
7210	-10°	
7300	0	
7310	-10°	
7400	0	
7410	-10°	
7500	0	
7510	-10°	

Unit: mm



How to Use a Blade Type Multipoint Diamond Dresser

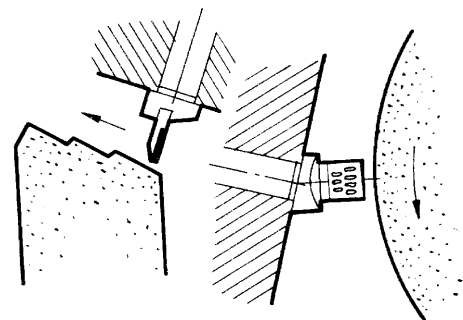

Standard Design

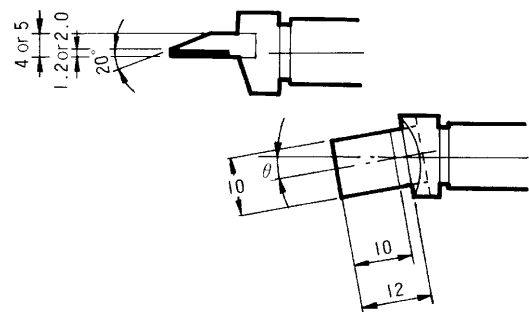

IMPREGNATED DRESSERS [Soft Bond]

The recommended usage of impregnated dressers is for adjusting the surface and form of the grinding wheels for cylindrical applications, etc. Impregnated Dressers have a fine diamond powder bonded in a soft metal, and they can cleanly adjust grinding wheels with sharp shapes.

Impregnated Dresser Grit Size

Grinding Wheel Grit Size	Diamond Grit Size
#54	C
#60~100	M
#120~220	F
#240~400	#120~

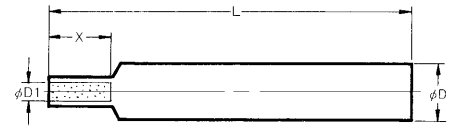

Code No.	D1	X	D	L
8101	3	3	8	50
8102	3	5	10	50
8103	3	8	11	50
8104	4	5	8	50
8105♦	4	8	11	50
8106	4	10	11	50
8107	5	5	8	50
8108	5	8	10	50
8109♦	5	10	11	50
8110	3	3	6	25
8111	5	5	6	30

♦Standard stock items
8105 Diamond Grit Size #80/100
8109 Diamond Grit Size #60/80

Unit: mm

BOND DRESSERS [Impregnated Dresser (Hard Bond)]

This dresser has diamond powder spread evenly throughout a super hard alloy. This powerful dresser is suited to center-less grinding wheels. Compared with traditional singlepoint diamond dressers, the edges of multiple diamonds in the bond diamond dresser continuously work evenly on the grinding wheel, providing optimal grinding conditions. The bond dresser is lower priced, and it will increase your grinding performance durability, and it is a dresser with great cost-performance.

Bond Dressers	Symbol	Grit Size	Number
	C	Coarse	4
	M	Medium	6
	F	Fine	8

BD-2-M-221







Code No.	Diamond Layer Shape	Cross-section	Code No.
BD-1	Cone	R Shape	
BD-2	Oblong	A Shape	
BD-3	Tip angled on one side		
BD-4	V-shaped tip (width-ways)		
BD-5	V-shaped tip (length-ways)		
BD-6	Special shape		

Shape	Code No.	Diamond part dimensions	Axis Dimensions	Usage area
	BD-1	110♦ 120♦ 130♦ 6dx7ℓ 8dx7ℓ 10dx7ℓ	Standard 11 x 50 L (You can also specify your own dimensions)	Dressing and truing of standard grinding wheels
	BD-2	210♦ 220♦ 230♦ 4Wx10Lx7ℓ 6Wx13Lx7ℓ 6Wx20Lx7ℓ	Standard 11 x 50 L (You can also specify your own dimensions)	Dressing and truing of center-less, conical and flat grinding wheels
	BD-2	211 221♦ 231 4Wx10Lx7ℓ 6Wx13Lx7ℓ 6Wx20Lx7ℓ	Standard 11 x 50 L (You can also specify your own dimensions)	Dressing and truing of center-less, conical and flat grinding wheels

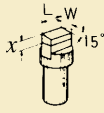
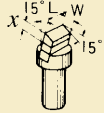
♦Standard stock items

Unit: mm



Shape	Code No.	Diamond part dimensions	Axis Dimensions	Usage area
	BD-2	212 4Wx10Lx10% 222 6Wx13Lx7% 232 6Wx20Lx7%	11Øx50L(Stepped)	Dressing and truing of center-less, conical and flat grinding wheels
	BD-3	310 4Wx10Lx8% \times 15° 320 6Wx13Lx8% \times 15° 330 6Wx20Lx8% \times 15°	11Øx50L(Stepped)	Dressing and truing of center-less, conical and angled grinding wheels
	BD-3	311 4Wx10Lx8% \times 15° 321 6Wx13Lx8% \times 15° 331 6Wx20Lx8% \times 15°	11Øx50L(Stepped)	Dressing and truing of center-less, conical and flat grinding wheels
	BD-3	312 4Wx10Lx8% \times 15° 322 6Wx13Lx8% \times 15° 332 6Wx20Lx8% \times 15°	11Øx50L(Stepped)	Dressing and truing of center-less, conical and angled grinding wheels
	BD-4	410 4Wx10Lx9% \times 90° 420 6Wx10Lx10% \times 90°	11Øx50L(Stepped)	Dressing and truing of angled grinding wheels
	BD-4	411 4Wx10Lx9% \times 90° 421 6Wx10Lx10% \times 90°	11Øx50L(Stepped)	Dressing and truing of angled grinding wheels
	BD-4	412 4Wx10Lx9% \times 90° 422 6Wx10Lx10% \times 90°	11Øx50L(Stepped)	Dressing and truing of angled grinding wheels
	BD-5	510 6Wx10Lx13% \times 90° 520 6Wx13Lx13% \times 90° 530 8Wx13Lx13% \times 90°	11Øx50L(Stepped)	Dressing and truing of angled grinding wheels
	BD-5	511 6Wx10Lx13% \times 90° 521 6Wx13Lx13% \times 90° 531 8Wx13Lx13% \times 90°	11Øx50L(Stepped)	Dressing and truing of angled grinding wheels

Unit: mm

BLOCK DRESSERS

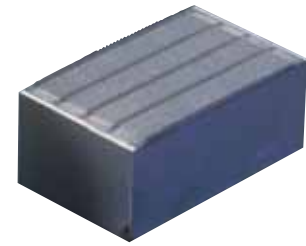

In general, block dressers are used to profile surface grinding wheels, replacing other radius shaping methods. The block dresser has a cross section that matches that of the grinding material, and its cross-section is lined with diamonds carefully impregnated using a special procedure. It is especially effective in forming concave shapes, and excels at reproducing precise shapes with a radius of 0.2 ~ 1mm, and a width of over 0.5, and can increase your performance.

- (4) Does not require a high level of proficiency to perform dressing.
- (5) Processes can be shortened

Characteristics

- (1) Reduction of forming time
- (2) Excels at reproducing precise shapes
- (3) Easily attached and does not require a jig

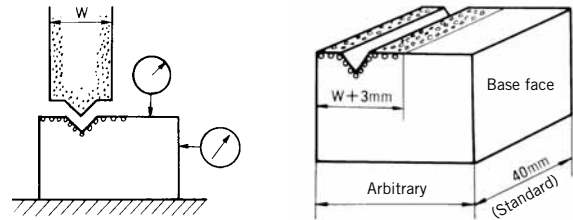

Convex shapes

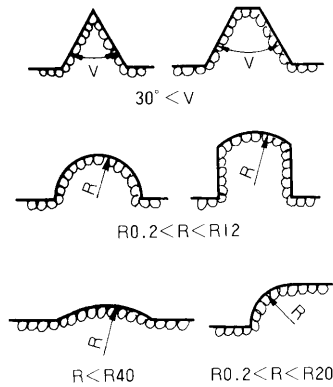

Concave shapes

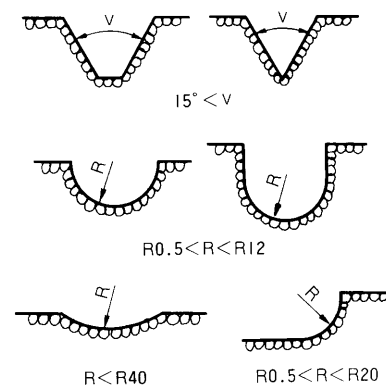

Pitch shapes (Repeated shapes)



When placing an order, please provide the grinding wheel width, work charts, method of attachment, and finished face roughness, etc.

For setting the inside with of the grinding wheel

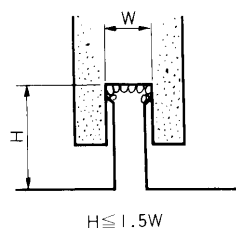

For setting the outside width of the grinding wheel

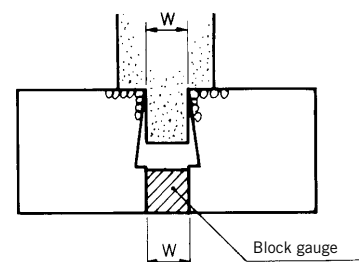

ROLLER DRESSERS

For mass production of single parts, which require diamond tools that have the same shape as the finished product, and the precision of its shape and dimensions must exceed those of the finished product. If you use a roller dresser, there is no need for copying devices, and you can transfer complicated shapes to the grinding wheel just by running the roller dresser over it.

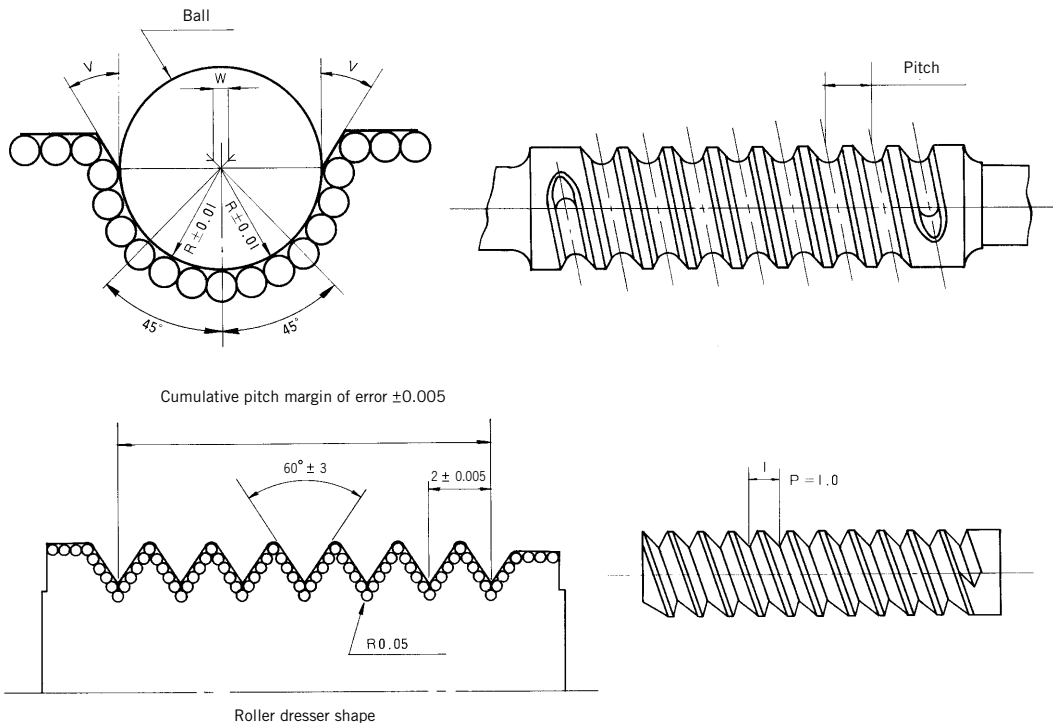

Characteristics

- Drastically reduce time spent forming the grinding wheel
- Reduce the time spent changing dressers to a minimum
- Precise dimensions can be reproduced in a wide range of products
- The quality of the finishing face of the grinding wheel is steady and improves
- Reduces wear on the grinding stone
- Reduces labor time

All these points contribute to a large increase in productivity

This product really excels in the forming of profiled grinding wheels.

Uses

Car parts:

Crankshafts, camshafts, steering worms, ball stud knuckle spindles, output shafts, valves, splined shafts, fuel injection nozzles, spools.

Bearing parts:

Ball bearings, roller bearings, bearing cases,

Turbines:

Christmas trees, guide vanes

Others:

Taps, gears for oil pumps, connecting rods for plunger pumps, rotors for compressors, worm gears, etc.



Asahi Diamond Industrial Co., Ltd.

URL: <http://www.asahidia.co.jp/>

The New Otani Garden Court, 11th Floor 4-1, Kioi-cho, Chiyoda-ku, Tokyo 102-0094, Japan



Tamagawa Factory
Yamanashi Asahi Diamond
Industrial Co., Ltd.

Shape the Innovation

私達の革新で、お客様の革新をカタチにする